

TECHNO MODULE

MODULAR
ELSTEEL
ENCLOSURES



INTRODUCTION

ELSTEEL is a world leader in the design, development and manufacture of modular panel enclosures.

This is built on a strong foundation of 40+ years of operations supported by consistent investment in research and development. Our objective is as simple as our products: To manufacture the world's best enclosures at the best possible price.

ELSTEEL delivers enclosure solutions for every build. Whether it is a small Terminal Box or the largest custom designed distribution panel for an Olympic Size Stadium, ELSTEEL delivers the solution.



You're holding a top of the line quality product in your hands. Made with love and excellence! I hope you will enjoy assembling and using Elsteel products as much as I enjoy manufacturing it for you.

A stylized, handwritten signature in white ink.

Fang Logstrup
Managing Director





TECHNO MODULE

Techno Module is a patented 200 mm grid modular system for the switchboard manufacturing industry, fully type tested in accordance with IEC 61439-2.

It is the result of many years work in research and development and continuous testing at recognised test stations around the world.

Techno Module is an open system that can accommodate all major brands of breakers, contactors, relays etc.

THE TECHNO MODULE DESIGNER

Panel properties

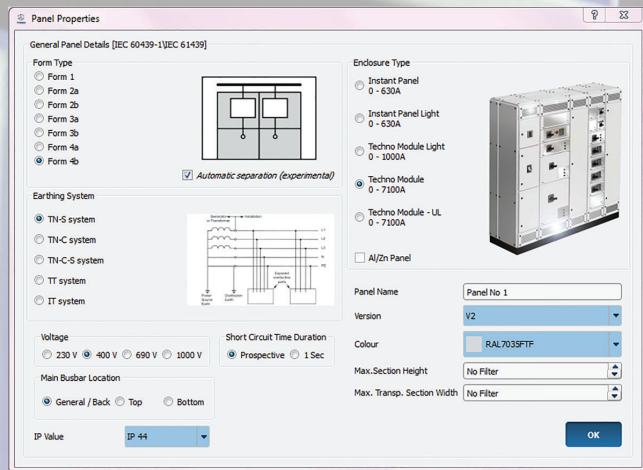

2D view

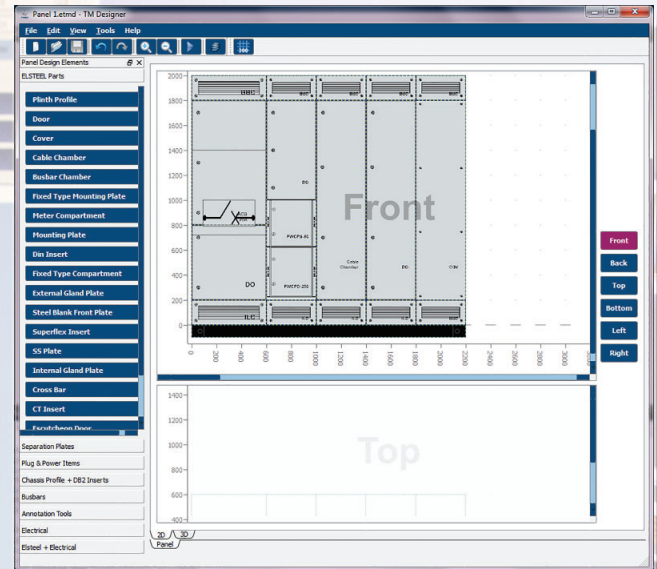

3D view

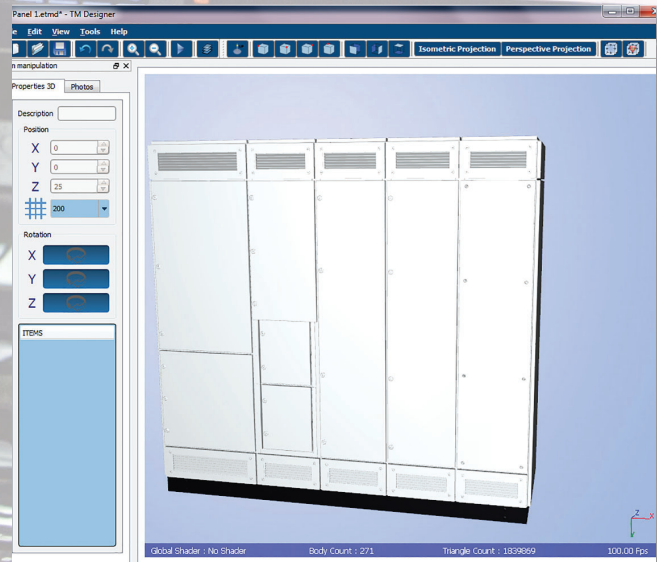
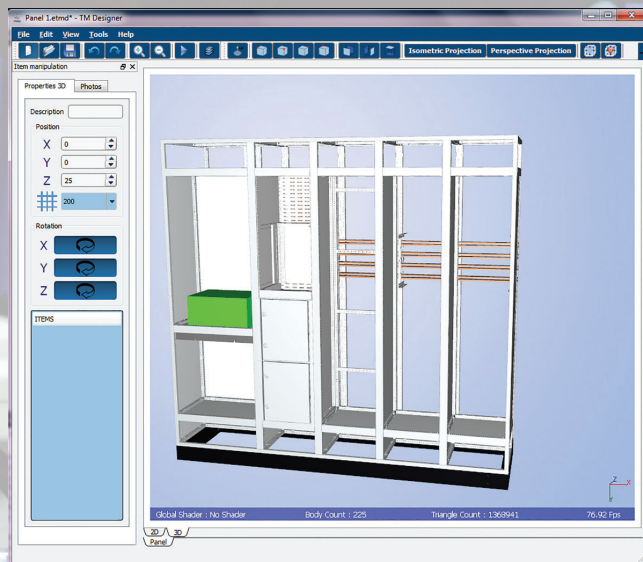

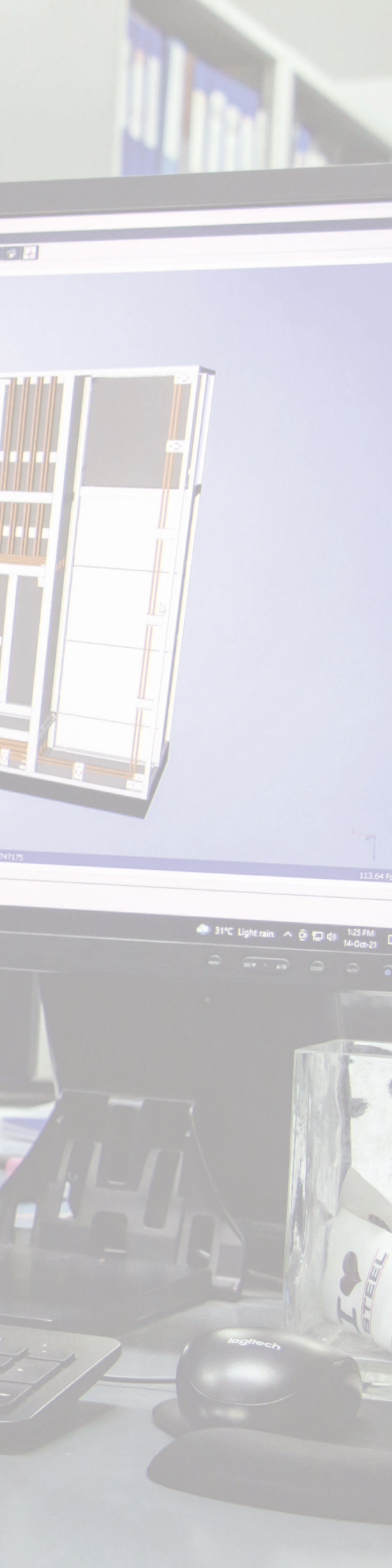

The first step in designing a successful distribution board or motor control centre is planning with Techno Module Designer (TMD).

Panel builders spend a lot of time quoting projects with a success rate as little as 5-10%. So in order to save engineers precious time on quoting and allow them more time with the customer, we have created a unique tool. Within 15 minutes you can draw a panel board and get a Bill of Material including copper and electrical items. Its fast and its free!

Another great feature is the software creates 3D drawings for each panel. View in TMD or export into other 3D software packages. You can then plan site wide busbar routes for example.

Spend less time calculating and more time selling.

FRAME WORK

The Techno Module system is modular in steps of 200 mm in all three directions.

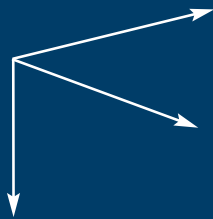

That means that there is no limit to the possibilities and positions.

The strong framework is made from 2 mm electro galvanised powder coated steel profile.

It forms a 25 mm grid and can be arranged in an unlimited number of ways.

It rests on a modular base frame which incorporates all facilities for dividing and transportation.



BUSBARS

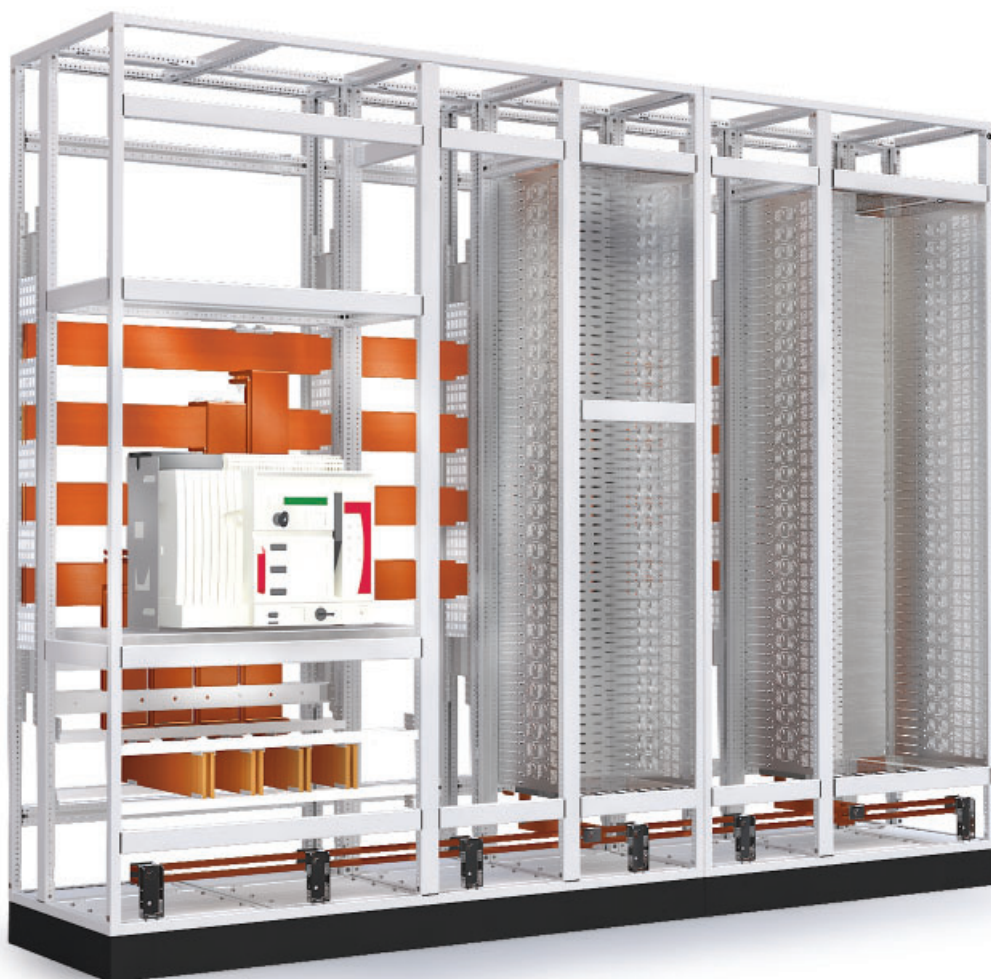

**Busbar systems use standard
'off the shelf' 10mm flat copper bars.**

The busbar holders are made from specially formulated, reinforced, self extinguishing plastic and can be mounted in any position within the framework. Top, bottom or middle.

Rated current

I_n = up to 12'000A

I_{cw} = up to 100kA - 3s and 150kA - 1s

Busbar systems and holders have been tested rigorously. Busbar connections are a clamp arrangement that allows the bars to slide during increase and decrease in temperature. This eliminates the risk of lose connections and of debris in your panel.

PLUG & POWER

PLUG & POWER system is essential for industries with critical requirements of uninterrupted power supply and high stacking density of installed components.

PLUG & POWER is suitable for both Motor Control Centers (MCC) and Power Distribution Centers (PDC).

Thanks to compliance with the highest safety standards, PLUG & POWER withdrawable units can be rearranged and “swapped-out” while busbars remain live without causing damage or affecting performance of a switchboard.

Excellent performance characteristics of the PLUG & POWER system and extensive range of accessories, you will comply with any project requirements.

Thanks to the high stacking density of our PLUG & POWER system and unit width options, internal component installation availability inside of the unit, you will use your available panel space in the most efficient way.

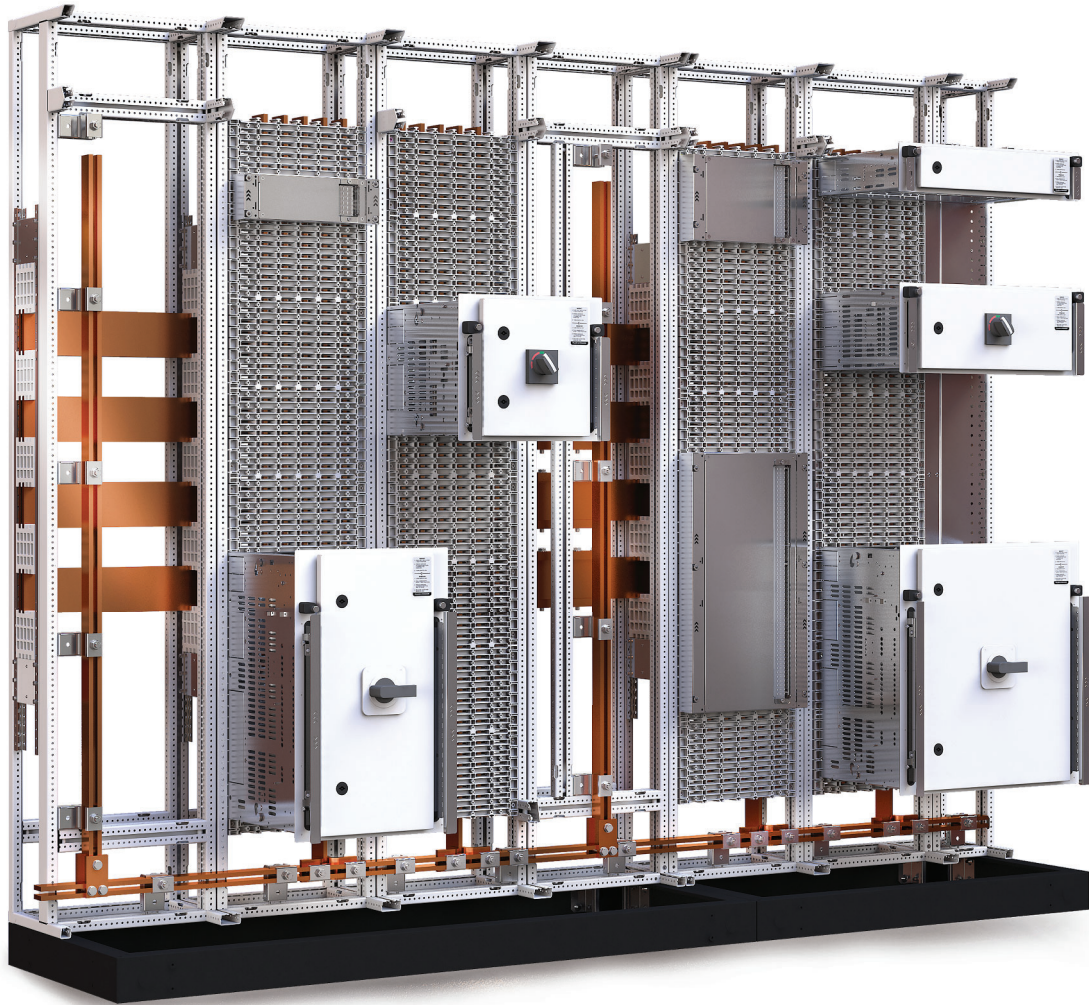

Patented

PLUG & POWER

PLUG & POWER busbar systems will help you select the most appropriate configuration for your application.

Both options provide high level of safety against access to hazardous parts (IP2X, complies with finger protection standards).

The busbar arrangement installed within the Mother Board can be equipped with Shutters (optional accessory) which can provide improved level of protection against access to hazardous parts (IP4X, not possible to touch by wire).

A wide range of acceptable busbars from 1×20 till 10×120 mm. Each section can carry up to 2850A @35°C and up to 2500A @50°C.

Wide range of short-circuit withstand ratings from 50-1s till 100 kA-1s.

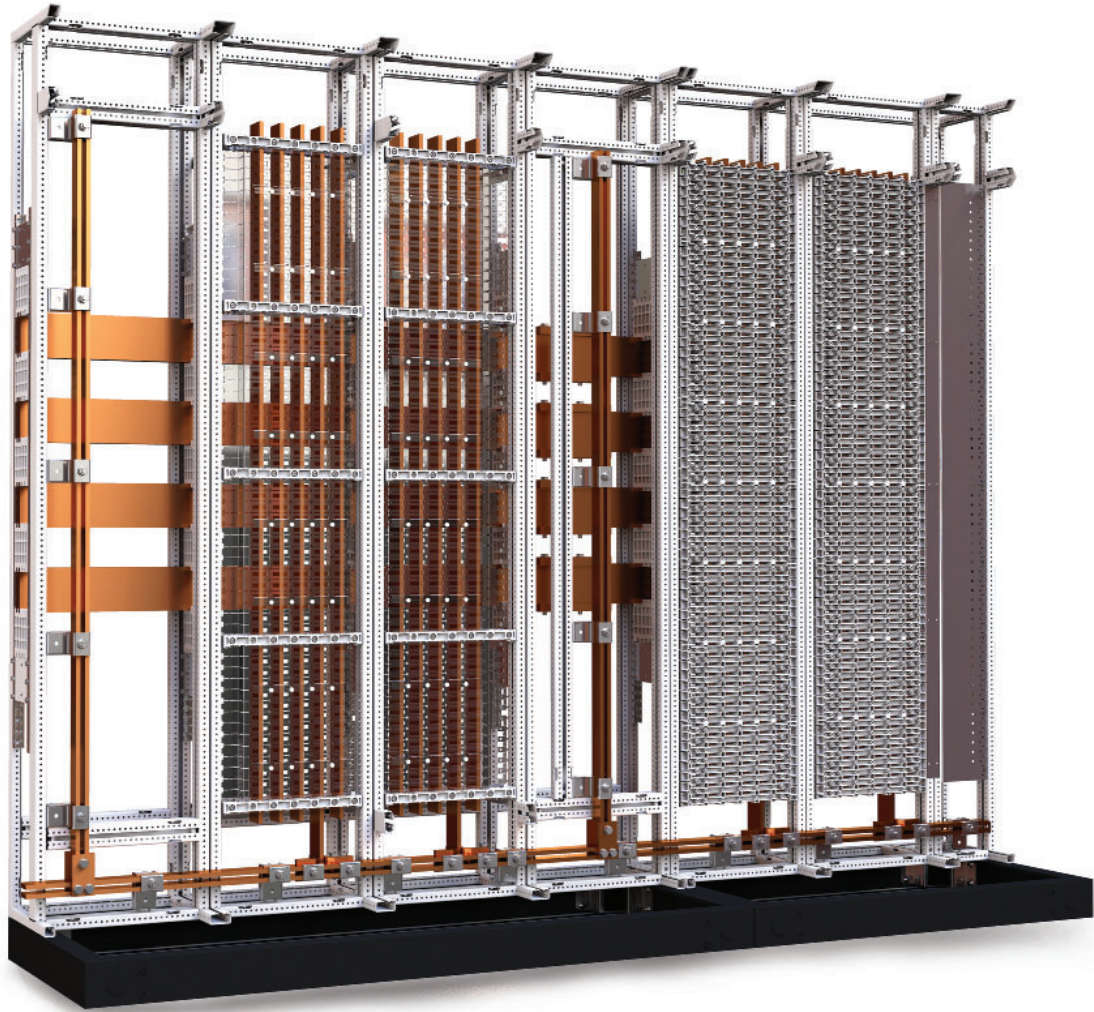

PLUG-IN UNITS

- Easy and low labour cost to assemble
- Special fixing screws reliably secure unit in the “Connected” position.
- Ergonomic removable handles make installation and removal of the unit easy and quick.
- Various installation options: individual compartment or group installation inside the compartment.
- Unified incoming plugs guarantee reliable connection.
- Side or rear connection of outgoing cables.
- Shutters provide additional protection of your personnel.



* Plug & Power is patented and a registered trade name owned by Elsteel.

WITHDRAWABLE UNITS

- High stacking density: up to 40 units in 600×2000 mm section.
- Unified design of the unit for side and rear cable outgoing connection will reduce variety of stock items, extremely saving time for designers and provide outstanding flexibility for end users.
- “Hot-swap” will extremely minimize your downtime.
- Lockable “Connected”, “Test” and “Isolated” positions guarantee simplicity, safety and reliability of operations.
- Integrated interlock will prevent unit removal in running (onload) condition and provide excellent level of safety for your personnel.
- High rated current: up to 900A.
- High number of auxiliary contacts (up to 84) and options of various digital communication interfaces broaden opportunities for designers, interfacing and end users.
- Interchangeable incoming and outgoing power plugs provide you reliable connection.
- Tin-plated terminals of power outgoing plugs allow to connect Al or Cu cables up to 4×240 mm² per phase.
- Shutters provide additional protection for your personnel.
- Insertion interlock will prevent installation in a wrong compartment.
- With Position indicator you will always know each position of the functional unit.
- Excellent mechanical operation resource: 1000 cycles.
- Lifting brackets will make process of installation or removal of heavy units easy and quick.

FORM 3 + 4

Highest forms of personal safety as well as protection of materials and environment.

When built in accordance with this change to the standard, it is possible to work in one section of the panel while the rest of the panel is still live.

Internal separation plates prevent foreign objects or particles from transferring from one section of the panel to another (resulting in a short circuit in a compartment that may be live). This prohibits the whole panel from becoming contaminated and complete panel damage.



ARC FAULTS

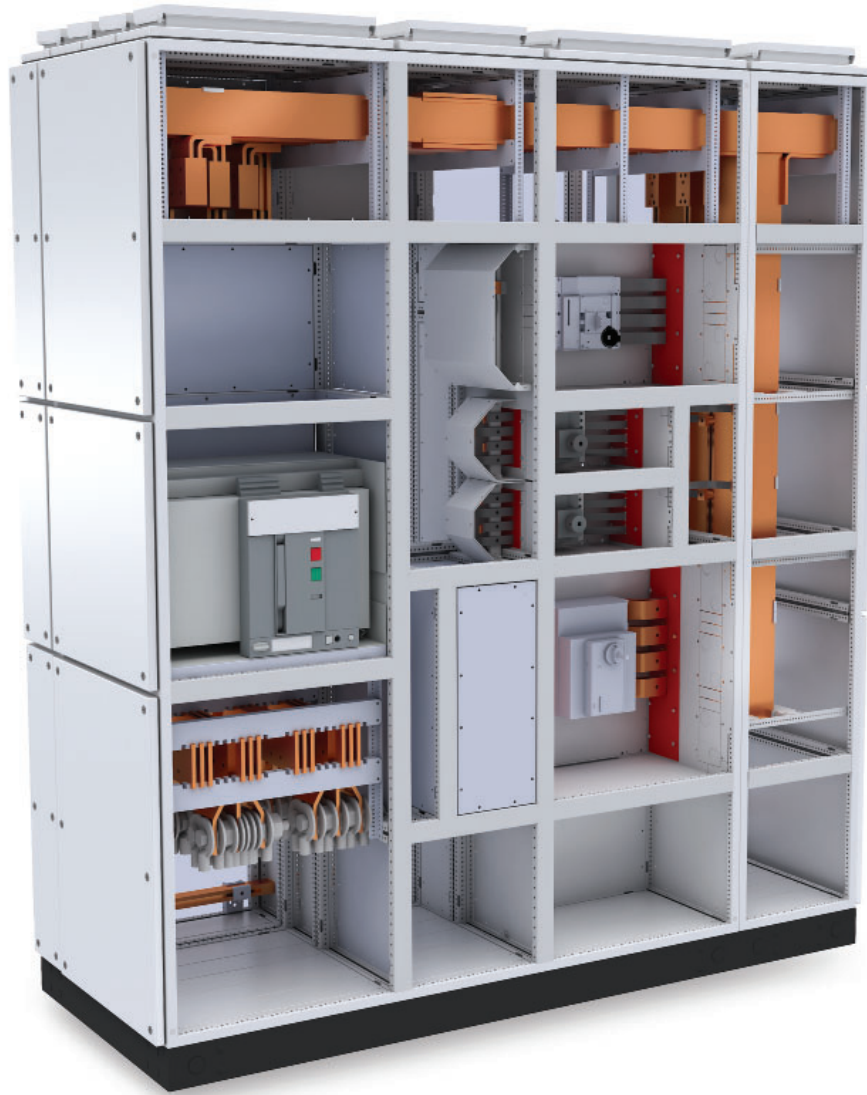

Arc Filters have been included in the design of the separation plate. Once you install the standard chimneys your enclosure is arc safe.

With arc filters fitted, flames, gases or solid objects are prevented from escaping from the front or side of the panel, where the operator may be standing.

Permissible short-circuit current under arcing conditions

$I_{p\ arc}$ = up to 100kA - 500 ms @415V

$I_{p\ arc}$ = up to 65kA - 300 ms @690V

TESTING + FINISH

Each and every panel is tested by the panel builder/integrator in accordance with specifications from the Constructors Manual, and the routine test specified in IEC 61439-1, before shipment.

The surface of the panel is powder coated in RAL 7035 fine textured finish. It's easy to maintain and will look 'as new' for many years.

Phosphated and chrome-passivated pretreatment makes the panel suitable for tough climates and conditions. Degree of protection up to IP55.

After commissioning, the panel is easily expanded and breakers or motor starters can be removed or fitted.



INSTALLATION COMMISSIONING

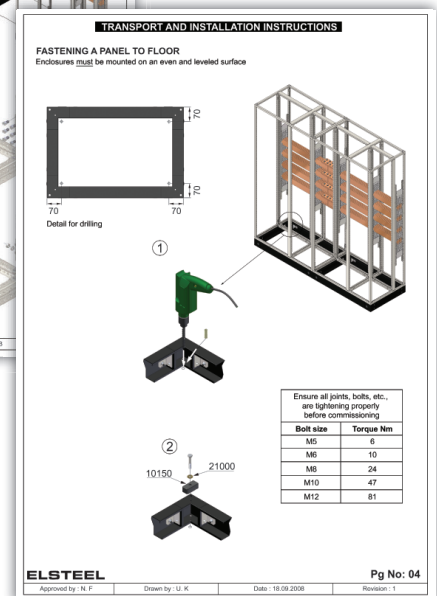
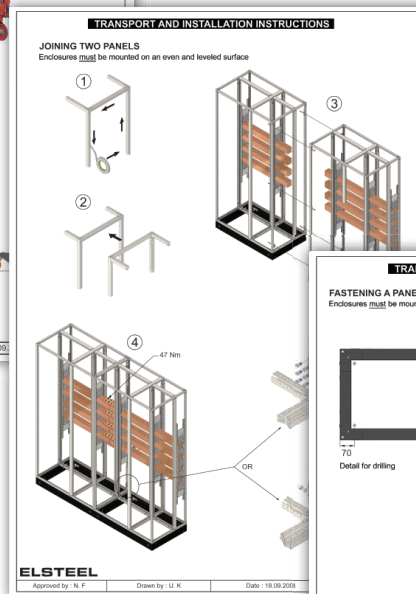
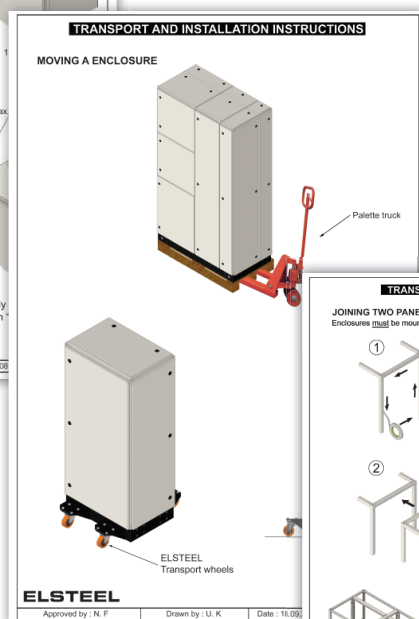
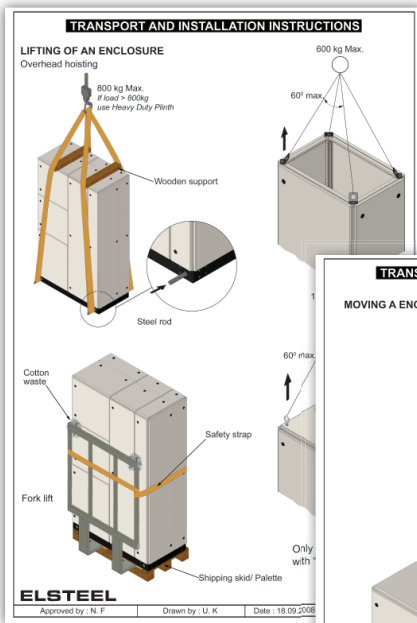

Every ELSTEEL enclosure is tested in accordance with IEC 61439-1, not only at the test station but also by the panel builder. Instructions are delivered with each panel explaining in detail how to safely transport and install the panel.

CERTIFICATION

Elsteel Techno Module System is certified as per IEC and UL standards by independent certification authorities.



Elsteel Techno Module System is fully verified as per IEC 61439-1, IEC 61439-2 and IEC TR 61641 with the following brands.



Elsteel Techno Module System is certified for marine applications by



Enclosure type	Breaker brand	Standard	Rated current of the assembly, I _{na}	Date of issue	Certificate No.
Techno Module	ABB	IEC 61439-2 ed 1.0 2009-01	800 A	August 2010	IPH-3345.2091256.0969
Techno Module	ABB	IEC 61439-2 ed 1.0 2009-01	800 A	September 2010	ASTA-17545
Techno Module	ABB	IEC 61439-2 ed 2.0 2011-08	1250 A	October 2014	DEKRA-2174125.102
Techno Module	ABB	IEC 61439-2 ed 1.0 2009-01	1600 A	August 2010	IPH-3345.2091255.0986
Techno Module	ABB	IEC 61439-2 ed 1.0 2009-01	1600 A	September 2010	ASTA-17544
Techno Module	ABB	IEC 61439-2 ed 2.0 2011-08	1600 A	October 2014	DEKRA-2174125.101
Techno Module Light	ABB	IEC 61439-2 ed 3.0 2020-07	1600A	May 2022	DEKRA-2254507.100
Techno Module	ABB	IEC 61439-2 ed 2.0 2011-08	2300 A	August 2010	IPH-3345.2091254.0982
Techno Module	ABB	IEC 61439-2 ed 2.0 2011-08	2400 A	June 2011	IPH-3457.2100397.1032
Techno Module	ABB	IEC 61439-2 ed 2.0 2011-08	2500 A	September 2010	ASTA-17543
Techno Module	ABB	IEC 61439-2 ed 2.0 2011-08	2500 A	June 2011	IPH-3457.2100397.0221
Techno Module	ABB	IEC 61439-2 ed 2.0 2011-08	2500 A	August 2011	ASTA-18050
Techno Module	ABB	IEC 61439-2 ed 2.0 2011-08	2500 A	January 2013	ASTA-18741
Techno Module	ABB	IEC 61439-2 ed 2.0 2011-08	2500 A	October 2014	DEKRA-2174125.100
Techno Module	ABB	IEC 61439-2 ed 2.0 2011-08	3200 A	January 2013	ASTA-18740
Techno Module	ABB	IEC 61439-2 ed 1.0 2009-01	3400 A	August 2010	IPH-3345.2091253.0999
Techno Module	ABB	IEC 61439-2 ed 1.0 2009-01	4000 A	September 2010	ASTA-17542
Techno Module	ABB	IEC 61439-2 ed 1.0 2009-01 & IEC 61439-2 ed 2.0 2011-08	4000 A	September 2010	IPH-3345.2091252.1010
Techno Module	ABB	IEC/TR 61641: Edition 3.0 2014	4000 A (415V)	April 2022	DEKRA-2254512.01-AOC
Techno Module	ABB	IEC/TR 61641: Edition 3.0 2014	4000 A (690V)	April 2022	DEKRA-2254512.02-AOC
Techno Module	ABB	IEC 61439-2 ed 1.0 2009-01	6300 A	September 2010	ASTA-17541
Techno Module	ABB	IEC 61439-2 ed 2.0 2011-08	6300 A	January 2021	DEKRA-2242142.100
Techno Module	ABB	IEC 61439-2:2020	6300 A	June 2022	DEKRA-2254503.100
Techno Module	ABB	IEC 61439-2 ed 3.0 2020-07	10000 A	September 2022	DEKRA-2256032.100
Techno Module Light	General Electric	IEC 61439-1 ed 2.0 2011-08 IEC 61439-2 ed 2.0 2011-08	1000 A	December 2012	IPH-1819.2130777.0451
Techno Module	General Electric	IEC 61439-2 ed 2.0 2011-08 & IEC 61439-1 ed 2.0 2011-08	2500 A	December 2013	IPH-1819.2130776.0500
Techno Module	General Electric	IEC TR 61641 ed 3.0 2014-09	2500 A	August 2015	IPH-02996-15-0516
Techno Module	Hager	IEC 61439-2 ed 2.0 2011-08	1300 A	June 2019	DEKRA-2197839-102
Techno Module	Hager	IEC 61439-2 ed 2.0 2011-08	2000 A	January 2016	DEKRA-2184741-101
Techno Module	Hager	IEC 61439-2 ed 2.0 2011-08	3200 A	January 2016	DEKRA-2184741-100
Techno Module	Hager	IEC 61439-2 ed 2.0 2011-08	6100 A	June 2019	DEKRA-2197839-103
Techno Module	LSiS	IEC 61439-2 ed 2.0 2011-08	1600 A	February 2017	DEKRA-2195091-100

For more certifications and latest updates please see www.elsteel.com

Enclosure type	Breaker brand	Standard	Rated current of the assembly, I _{na}	Date of issue	Certificate No.
Techno Module	LSiS	IEC 61439-2 ed 2.0 2011-08	2500 A	February 2017	DEKRA-2195091-101
Techno Module	LSiS	IEC 61439-2 ed 2.0 2011-08	4000 A	February 2017	DEKRA-2195091-102
Techno Module	Mitsubishi Electric	IEC 61439-1 ed 2.0 2011-08 & IEC 61439-2 ed 2.0 2011-08	3200 A	May 2018	NSC-171212-00004
Techno Module	Schneider Electric	IEC 61439-2 ed 1.0 2009-01	400 A	July 2011	ASTA-18047
Techno Module	Schneider Electric	IEC 61439-2 ed 2.0 2011-08	400 A	June 2012	ASTA-18361A
Techno Module	Schneider Electric	IEC 61439-1 ed 1.0 2009-01	800 A	July 2011	ASTA-18048
Techno Module	Schneider Electric	IEC 61439-2 ed 2.0 2011-08	800 A	June 2012	ASTA-18363A
Techno Module	Schneider Electric	IEC 61439-2 ed 1.0 2009-01	1600 A	December 2010	IPH-2633.2100582.0704
Techno Module	Schneider Electric	IEC 61439-2 ed 1.0 2009-01	1600 A	January 2011	ASTA-17864
Techno Module	Schneider Electric	IEC 61439-2 ed 2.0 2011-08	1600 A	June 2012	ASTA-18612A
Techno Module	Schneider Electric	IEC 61439-2 ed 1.0 2009-01	2500 A	December 2010	IPH-2633.2101351.0729
Techno Module	Schneider Electric	IEC 61439-2 ed 1.0 2009-01	2500 A	January 2011	ASTA-17865
Techno Module	Schneider Electric	IEC 61439-2 ed 1.0 2009-01	2500 A	July 2011	ASTA-18046
Techno Module	Schneider Electric	IEC 61439-2 ed 2.0 2011-08	2500 A	June 2012	ASTA-18362A
Techno Module	Schneider Electric	IEC 61439-2 ed 2.0 2011-08	2500 A	June 2012	ASTA-18613A
Techno Module	Schneider Electric	IEC 61439-2 ed 1.0 2009-01	3200 A	January 2011	IPH-3467.2100399.0218
Techno Module	Schneider Electric	IEC 61439-2 ed 1.0 2009-01	3200 A	February 2011	ASTA-17615
Techno Module	Schneider Electric	IEC 61439-1 ed 2.0 2011-08 & IEC 61439-1 ed 2.0 2011-08	3500 A	November 2012	ASTA-18868
Techno Module	Schneider Electric	IEC 61439-1 ed 1.0 2009-01	4000 A	November 2010	ASTA-17756
Techno Module	Schneider Electric	IEC 61439-1 ed 1.0 2009-01	4000 A	July 2011	IPH-2633.2100584.0506
Techno Module	Schneider Electric	IEC 61439-1 ed 2.0 2011-08	4000 A	June 2012	ASTA-18614A
Techno Module	Schneider Electric	IEC 61439-2 ed 2.0 2011-08	6300 A	June 2020	DEKRA-2232107.100
Techno Module	Siemens	IEC 61439-1 ed 2.0 2011-08	2000 A	February 2017	ASTA-20468
Techno Module	Siemens	IEC 61439-1 ed 1.0 2009-01	3200 A	February 2011	ASTA-17909
Techno Module	Siemens	IEC 61439-1 ed 2.0 2011-08	4900 A	February 2017	ASTA-20467
Techno Module	Siemens	IEC 61439-1 ed 2.0 2011-08 & IEC 61439-2 ed 2.0 2011-08	5740 A	February 2017	IPH-04104-16-0506
Techno Module	Terasaki	IEC 61439-2 ed 2.0 2011-08	1300 A	June 2012	DEKRA-2148971.100
Techno Module	Terasaki	IEC 61439-2 ed 2.0 2011-08	2000 A	June 2012	DEKRA-2148971.101
Techno Module	Terasaki	IEC 61439-2 ed 2.0 2011-08	3200 A	August 2017	DEKRA-2197839.100
Techno Module	Terasaki	IEC 61439-2 ed 2.0 2011-08	6100 A	August 2017	DEKRA-2197839.101

For more certifications and latest updates please see www.elsteel.com

TECHNICAL SPECIFICATION

GENERAL DATA

Installation		Indoor
		Outdoor ¹
Mounting possibilities		Floor standing
		Wall mounting
Colour		RAL 7035 Fine Textured (Standard) Other colours by request
Coating	Type	Epoxy Polyester Powder
	Thickness	≥ 60µm

MECHANICAL DATA

Service access		Front only
		Front & Rear
Cable entry		Top
		Bottom
Compartments		Fixed
		Removable
		Withdrawable
Degree of protection (IP code)		Up to IP55
Mechanical impact (IK code)		IK10
Form of internal separation	as per IEC61439-2	Up to 4b
	as per BS EN 61439-2	Up to 4 Type 1-7
Mechanical operation	Techno Module	1000 cycles
	Techno Module Light	200 cycles
Recommended dimensions of transport section	Length	Up to 2400 mm (can be extended)
	Height	Up to 2400 mm (can be extended)
	Depth	Up to 2400 mm (can be extended)

ELECTRICAL DATA

Rated operational voltage (U_e)		Up to 1000 V
Rated insulation voltage (U_i)		Up to 1000 V
Rated impulse withstand voltage (U_{imp})		Up to 12 kV
Rated frequency (f)		Up to 60 Hz
Rated current (I_n)	Main busbar	Up to 12000 A @ 35°C
		Up to 10000 A @ 50°C
	Functional unit ¹	Up to 6300 A @ 35°C
		Up to 5650 A @ 50°C
Rated short-time withstand current (I_{cw})		Up to 120 kA - 1s
		Up to 100 kA - 3s
Rated conditional short circuit current (I_{cc}) ²		Up to 100 kA @ 415 V
		Up to 100 kA @ 690 V
		Up to 100 kA @ 800 V
		Up to 90 kA @ 900 V
Pollution degree		3
Earthing system		TN-S, TN-C, TN-C-S, TT, IT

ELECTRICAL DATA (under arcing conditions)

Rated operational voltage (U_e)		Up to 690 V
Rated frequency (f)		50 Hz
Permissible short-circuit current under arcing conditions ($I_{p,arc}$)		Up to 100 kA @ 415 V
		Up to 65 kA @ 690 V
Permissible arc duration (t_{arc})		500 ms @ 415 V
		300 ms @ 690 V
Arcing class		C
Type of access		unrestricted access (ordinary persons)

¹ Outdoor installation is applicable for Stainless Steel Doors and Covers (AISI 304 grade or higher).

² Ratings depend on circuit breaker model and manufacturer. Refer test certificates on www.elsteel.com

BUSBAR HOLDER DATA

Type	Thermal Class (IEC 60085)	CTI (IEC 60112)	Material Group
BAH	Thermal Class B	175	IIIa
SLBH	Thermal Class F	600	I
UBH	Thermal Class B	175	IIIa
OMH	Thermal Class B	175	IIIa
BH	Thermal Class F	600	I
MAB	Thermal Class B	175	IIIa
MABHT	Thermal Class F	600	I
DRHU	Thermal Class F	600	I
INS	Thermal Class B	175	IIIa
NEU	Thermal Class B	175	IIIa
FCSH	Thermal Class B	175	IIIa
MBO	Thermal Class B	175	IIIa
RBH	Thermal Class B	175	IIIa

MATERIAL SPECIFICATION

Base Frame	Mild steel 2 mm Hot dip Galvanized steel 5 mm
Corners	Aluminium die casted
Corner Bar / Cross Bar	Electro Galvanized steel 2 mm Stainless steel 1.5 mm (AISI 304, AISI 316) Wet grinding (180)
Door / Cover	Mild steel 1.5 mm
Doors with Window	Mild steel 1.5 mm Tempered Tinted glass 4 mm
Door Stabilizer	Mild steel 20×20×1.5 square pipe
Flat Cover	Mild steel 1.5 mm Stainless steel 1.5 mm (AISI 304, AISI 316) Wet grinding (180)
Mounting Plate	Mild steel 2 mm Alu-zinc 2 mm Hot dip Galvanized steel 3 mm
Separation Plates	Mild steel 1 mm (sizes: 2.2, 2.4, 2.6, 4.4, 4.6), all other sizes 1.2 mm Polycarbonate 2 mm
Fixed Type Mounting Plate	Alu-zinc 2 mm
Group Mounting Plate	Alu-zinc 2 mm
Vertical Separation Plate	Alu-zinc 1.5 mm
Panel Assembly Kit	Mild steel zinc plated 3 mm
Cable Holder	Mild steel 1.5 mm (up to 600 mm) Mild steel 2 mm (above 600 mm)
Lifting Eyes	Mild steel zinc plated 3 mm
Wall Mounting Brackets	Mild steel zinc plated 3 mm
Transport Wheel Holder	Mild steel 3 mm
Instant Plate	Mild steel 1.5 mm
Busbar Holder	Self extinguishing fibre material / reinforced PC
Bracket for Earth Conductor	Mild steel zinc plated 3 mm

COPPER SPECIFICATIONS

Electrolytic Copper high conductivity OC-ETP 99.98 % JIS H3140 C 1100 Tempered upto half hard.

PAINT SPECIFICATION

1. Standard Paint

Degreasing and Phosphating

- By the spray method at approx. 47°C
- Cleaning and passivating of the surface
- Coating with phosphate (coat thickness approx. 1 µm)

Textured Powder Coating

- Electrostatic coating
- Raw material: Epoxy Polyester
- Can be readily overpainted
- Can be decontaminated
- High mechanical strength
- Good resistance to chemicals and UV rays coat thickness ≥ 70 µm

Smooth Powder Coating

- Electrostatic coating
- Raw material: Epoxy Polyester
- Can be readily overpainted
- Can be decontaminated
- High mechanical strength
- Good resistance to chemicals and UV rays coat thickness ≥ 60 µm

Corrosion resistance in accordance with IEC 62208 clause 9.13.1 and IEC 61439-2 clause 10.2.2.2

Severity test A

- 6 cycles of 24h each damp heat cycling test according to IEC 60068-2-30 (Test Db) at (40 ± 2) °C and relative humidity of 95%
- 2 cycles of 24h each to salt mist test according to IEC 60068-2-11 (Test Ka: salt mist) at a temperature of (35 ± 2) °C

Summary: No signs of rust, suitable for harsh industrial surrounding (Indoor installation)

2. Resistance

The standard coating is resistant to:

- Mineral oils
- Lubricants
- Machining emulsions
- Solvents (briefly, such as during cleaning processes)

The standard coating is suitable for a continuous temperature of -40°C to +90°C.

The standard coating can withstand a continuous temperature of 45°C to 85% RH.

Please Note

If UV resistant powder coating is required it has to be mentioned as a special requirement. The standard coating is not UV Resistant. IP protection categories do not imply that enclosures are suitable for outdoor applications.

3. Overpainting

After careful cleaning and perhaps slight roughening of the surface, the standard coating can be overpainted with Powder coating.

*Powder Coating System : Electrostatic Powder Coating System (ITW Gema – Switzerland)

*Pretreatment System : Five stage, Phosphate free Conversion Coating system (Henkel Germany)

For more certifications and latest updates please see www.elsteel.com

REFERENCES

Customer	Product	Country
Olympic Stadium	Main Distribution Panel	Australia
British Aerospace	Main Distribution Panel	Australia
Colt Telecom	Techno Module	Belgium
NATO Headquarters	Techno Module MCC	Belgium
Ministry of Defence	Motor Control Center	Dubai
Giga Gold Refinery	2500A LV Panels	Dubai
Jebel Ali Airport	Main Distribution	Dubai
Nordbahnhof Berlin	NSHV and GHV	Germany
Alcatel Stuttgart	NSHV and GHV	Germany
National Hospital	4000A Switchboard	Iceland
Eskifjord Ltd	2500A Switchboard	Iceland
Hyundai Motor India Ltd	Techno Module	India
Nokia Mobile Phone Facility Project	Techno Module	India
Toyota Kirloskar Motor Pvt Ltd	PCC Panels - Techno Module	India
Radisson Hotel	Techno Module/ Form 4	Jordan
Amman East Station	Form 4 Motor Control Center D/O	Jordan
Central Bank of Kenya	Main Board/ Sub Boards	Kenya
Commercial Bank of Africa	Main Board/ Sub Boards	Kenya
Multilinx Factory	Distribution Boards	Maldives
SAVANNAH Sugar Estate	Techno Module and MCC	Mauritius
Ulvesund Elektro AS	1600A Main Panels	Norway
Power Plant Mar Kraftverk	Motor Control Center	Norway
Qatar International Stadium	Distribution Panel	Qatar
West Bay Cooling System - Phase 1	Form 4 Panel 7000A	Qatar
SAB Miller Beer Factory	Motor Control Center WWT Plant	Romana
Hydro Tech Engineering	Motor Control Center WWT Plant	Romana
Esso Deepwater Ltd	Generator Control Panel	Singapore
Shangri La Hotel	Techno Module	Singapore
Greenpoint Stadium (2010 World Cup)	Techno Module	South Africa
Coca Cola Dar Es Salaam	Techno Module	South Africa
Barcelona Airport	Form 4 Motor Control Center	Spain
Jerez Airport	Form 4 Motor Control Center	Spain
Manchester Airport	Form 4 Motor Control Center	UK
Nokia	Main Switchboard	UK
International Airport Doha	Techno Module MCC	Qatar
Fujairah	Techno Module MCC	UAE
Brodosplit Shipyard	Marine Panel 6300A	Croatia

For more certifications and latest updates please see www.elsteel.com

MODULAR
ELSTEEL
ENCLOSURES



100% Danish
Technology

Møllevej 9 C · 2990 Nivå
Denmark
Tel +45 49 22 33 44
elsteel@elsteel.dk
www.elsteel.com